

Assembly Instruction

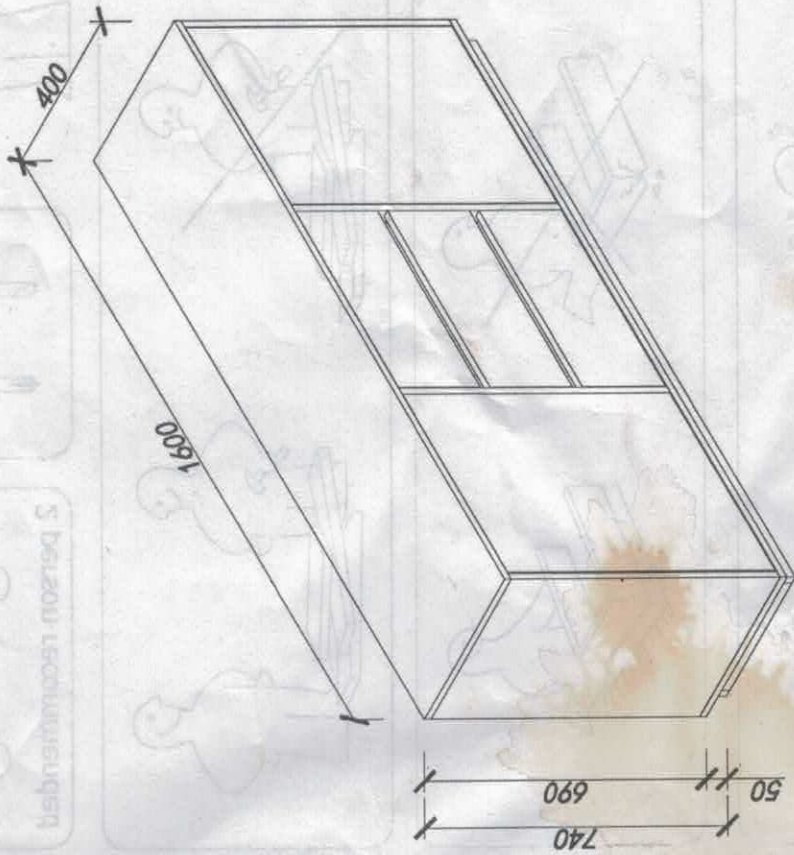

740

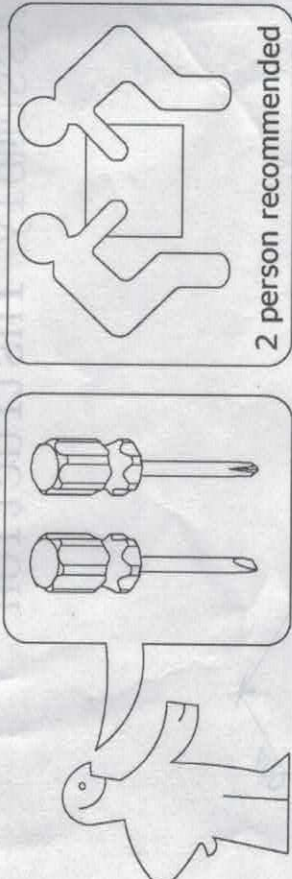

2 person recommended

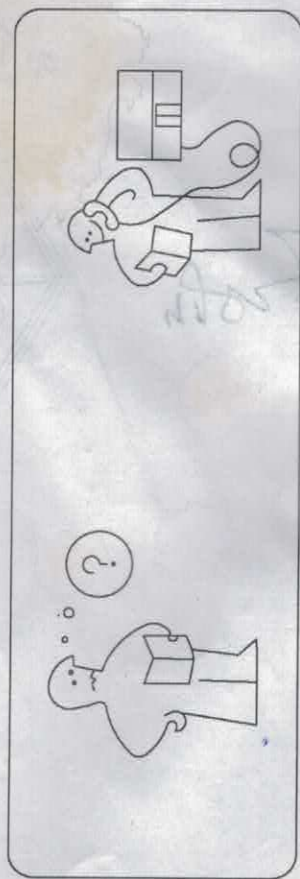
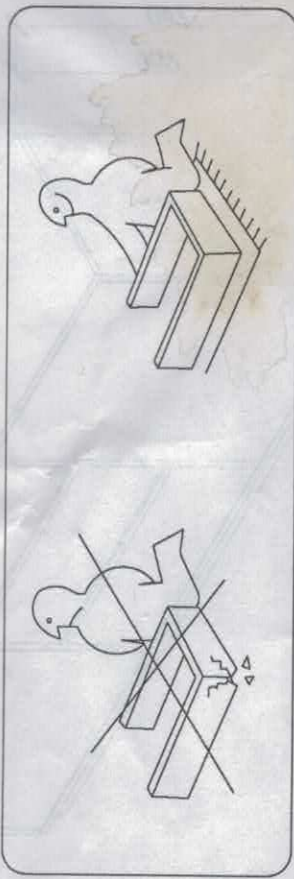
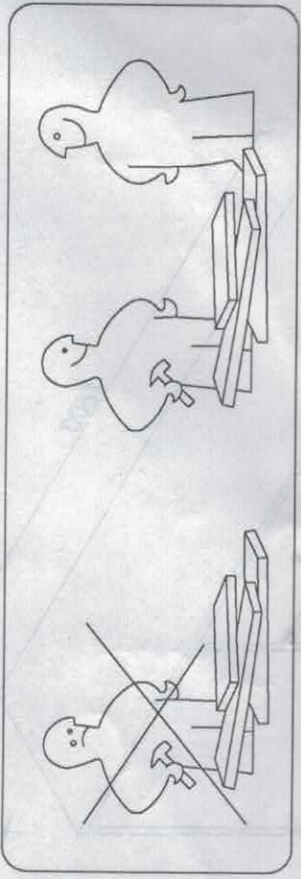

Panel No	Panel Sizes	Quantity
1	1800*400*16	1
2	1800*400*16	1
3	658*359*16	2
4	658*359*16	1
5	658*359*16	1
6	688*524*5	2
7	688*516*5	1
8	511*350*16	2
9	506*60*16	2

Panel No	Panel Sizes	Quantity
10	654*610*16	1
11	654*610*16	1
12	502*202*16	3
13	456*120*12	3
14	350*120*12	3
15	350*120*12	3
16	466*308*6	3
17	1510*60*16	2
18	308*60*16	3

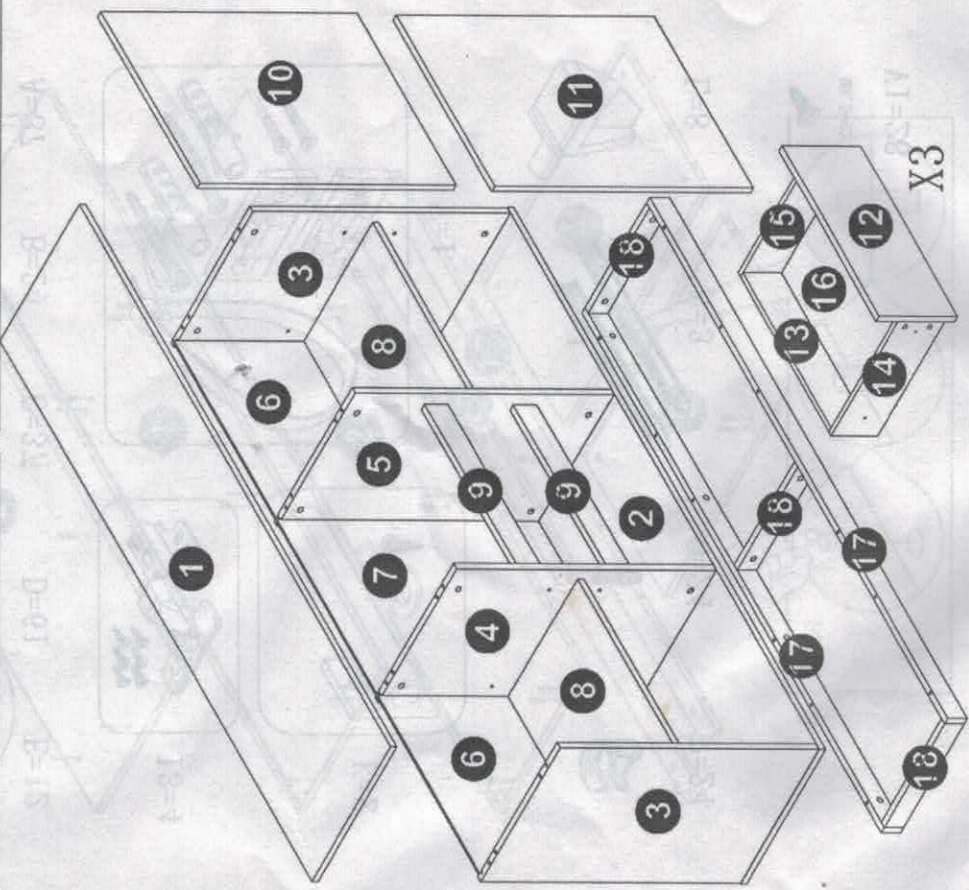

Fittings

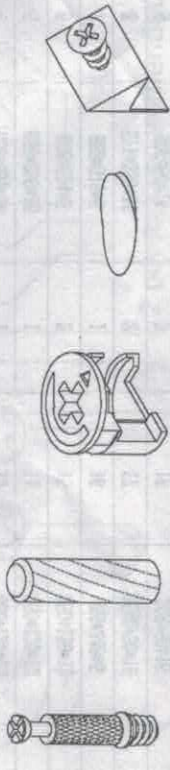

A=37 B=24 C=37 D=61 E=12

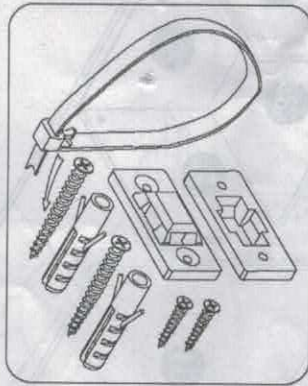

F=1

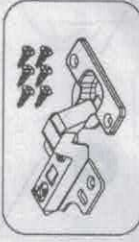

I3=4

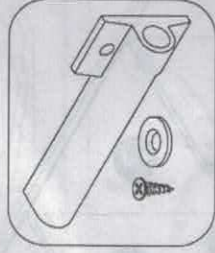

K=2



L=8



N=3



O=24



P=24



M3.5*12
V1=28

STEP 1

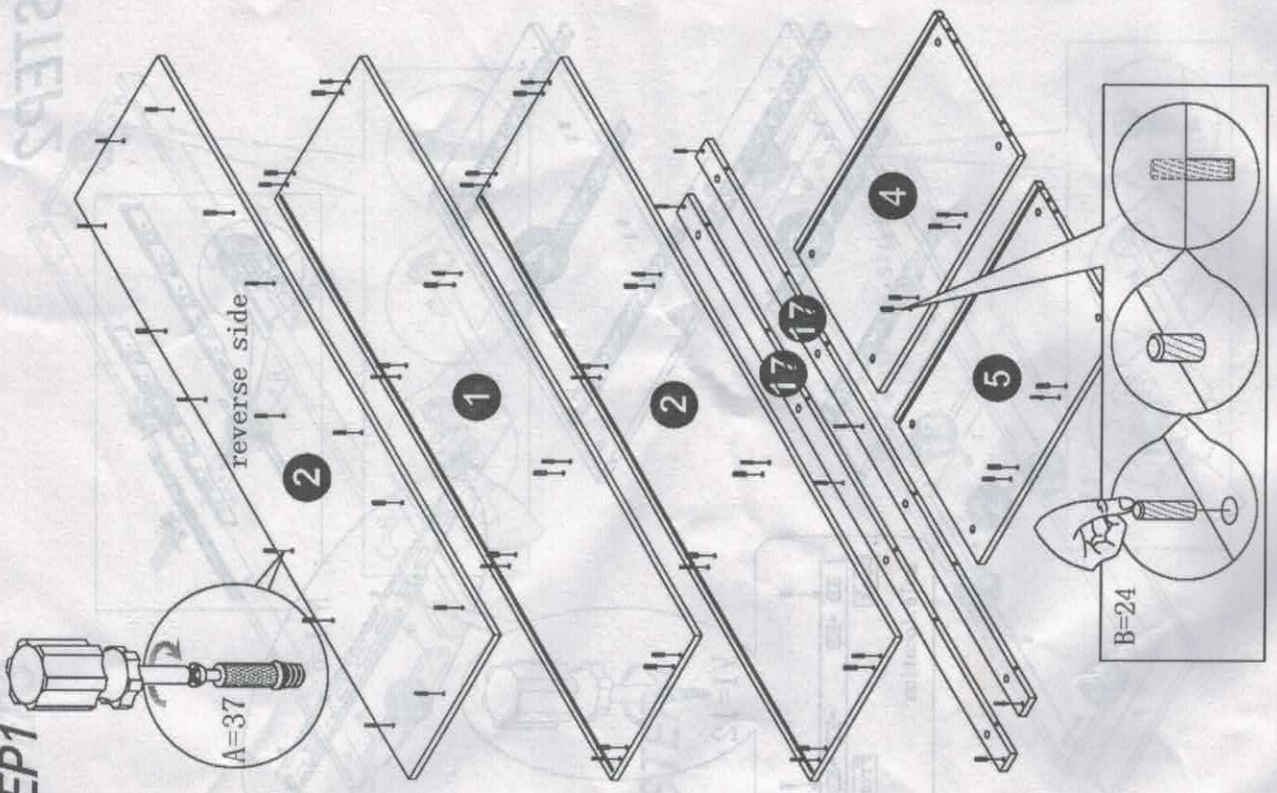

STEPS

STEP2

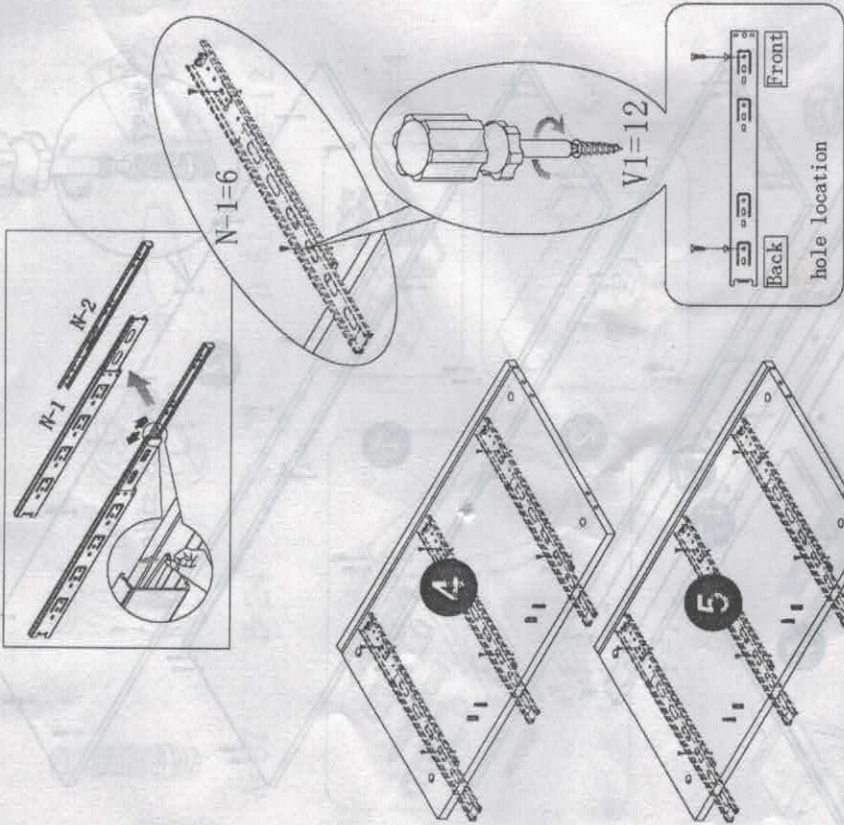

STEP3

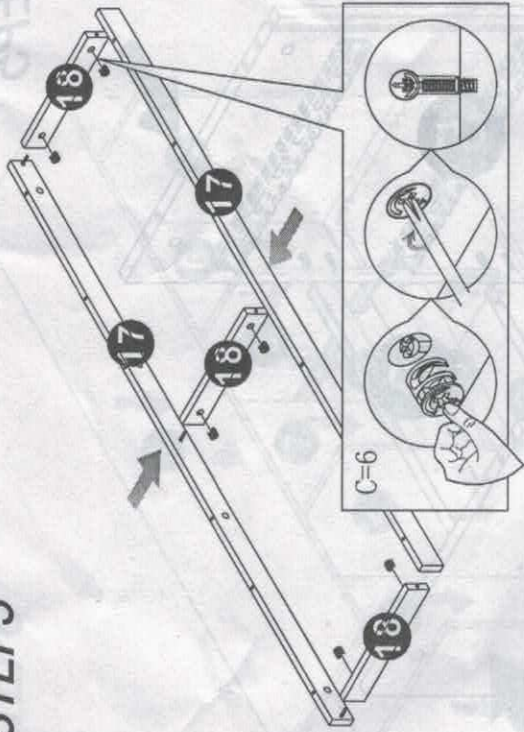

STEP4

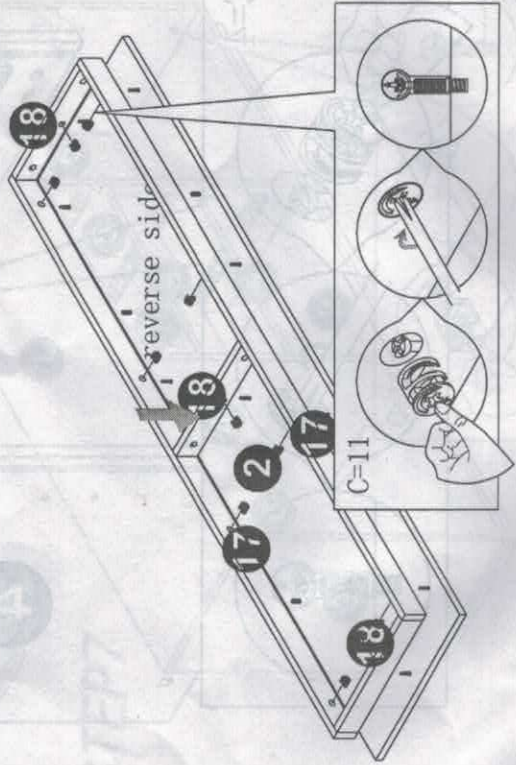

STEP5

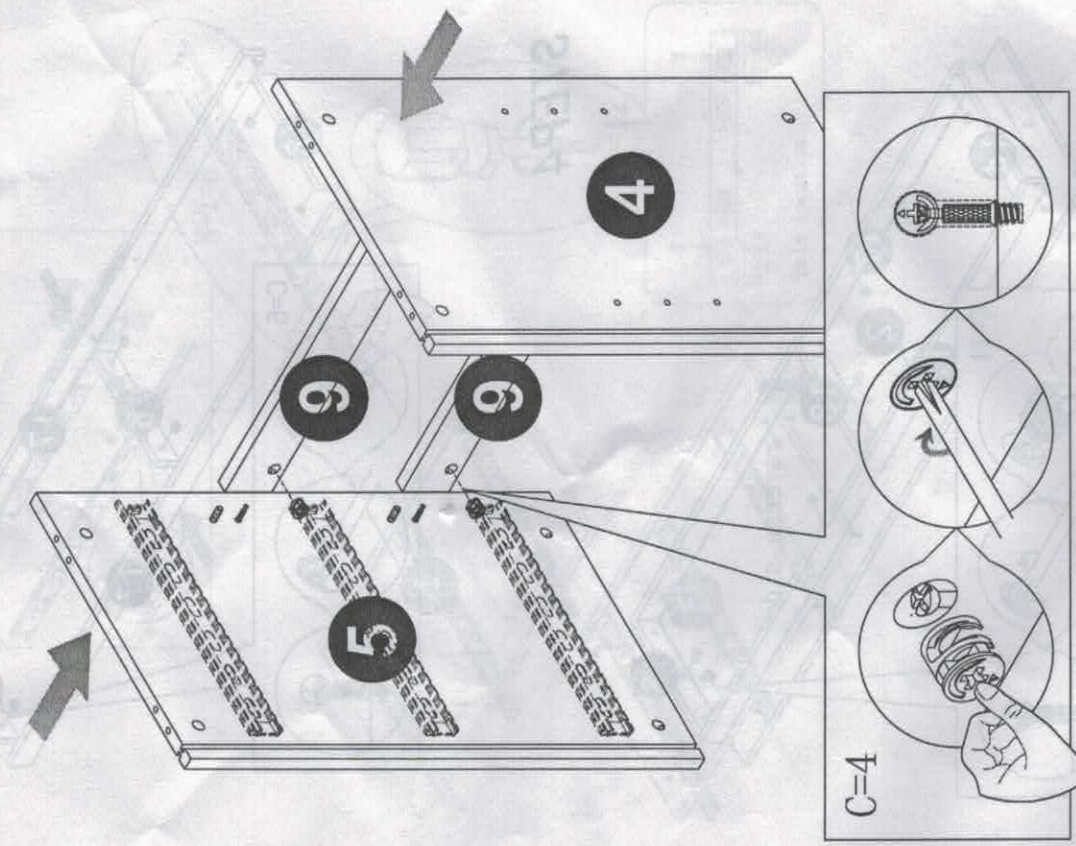

STEP6

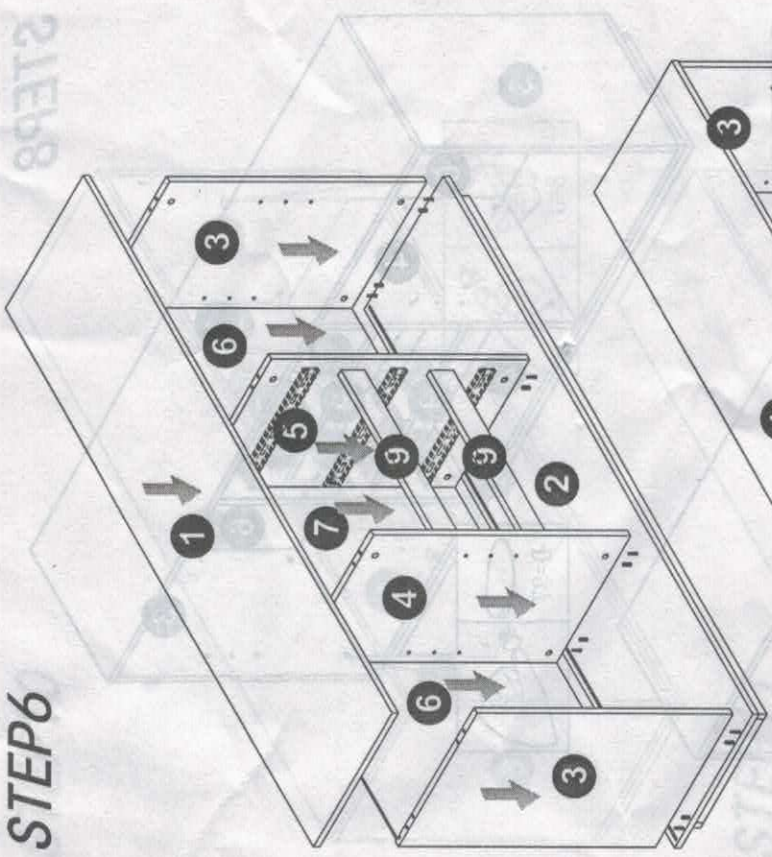

STEP7

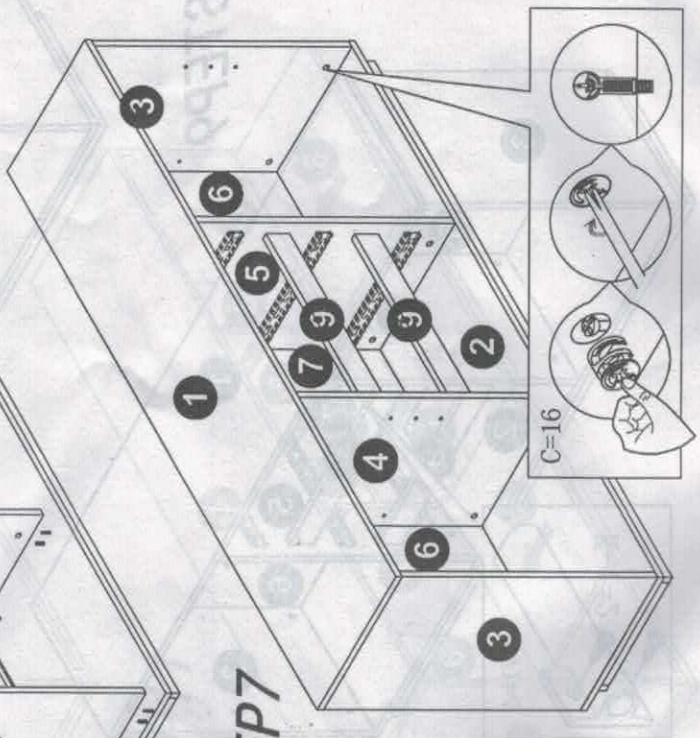

STEP8

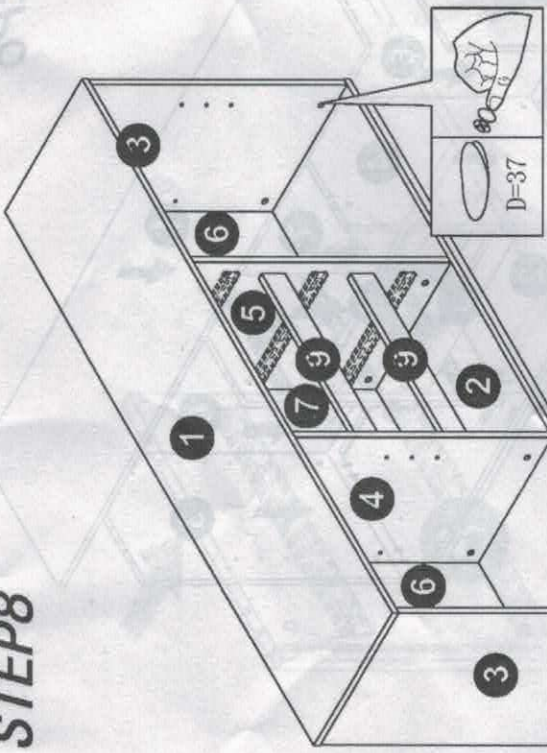

STEP9

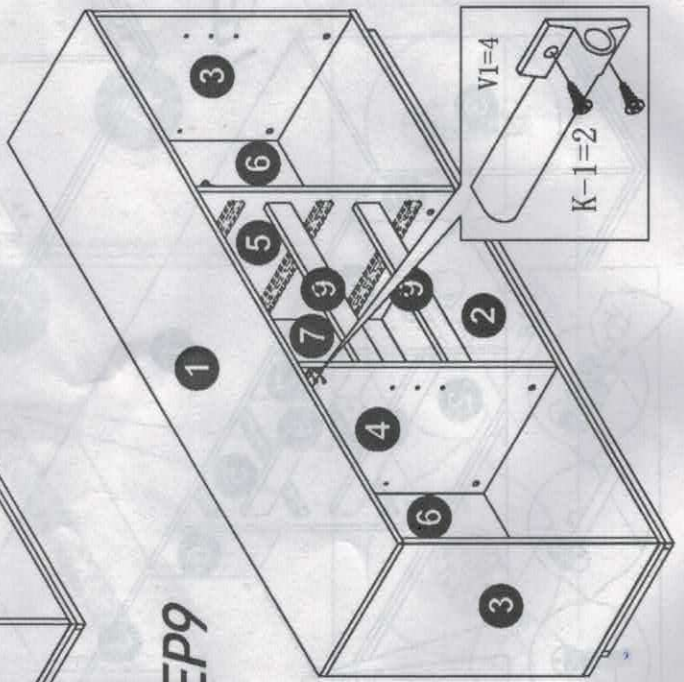

STEP10

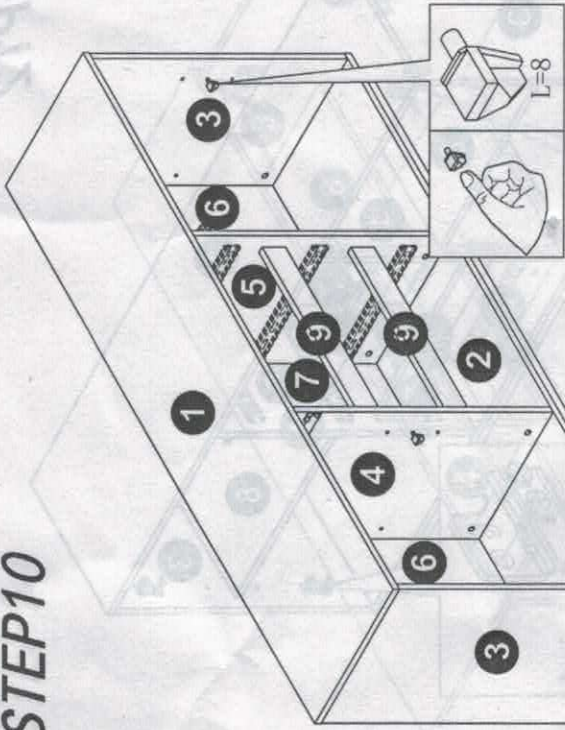

STEP11

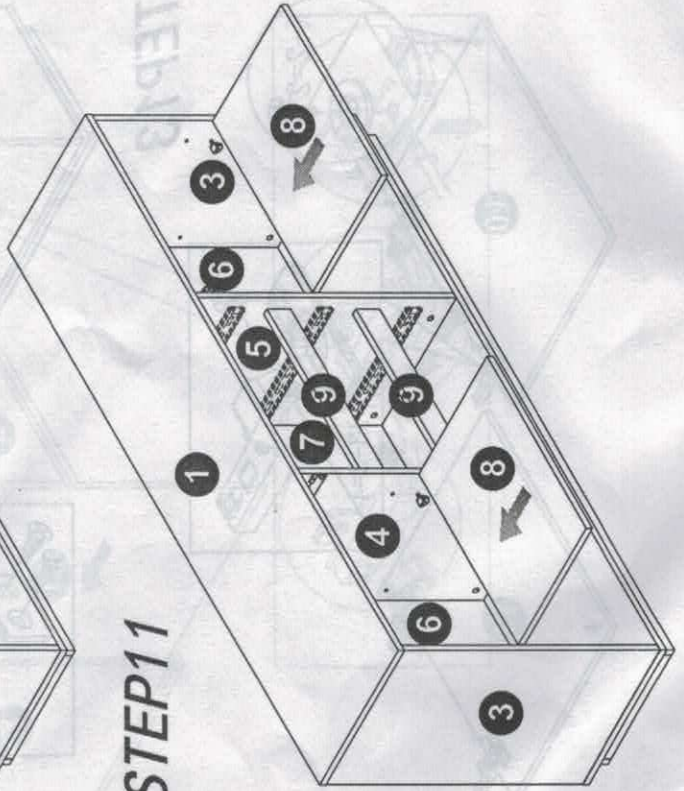

STEP12

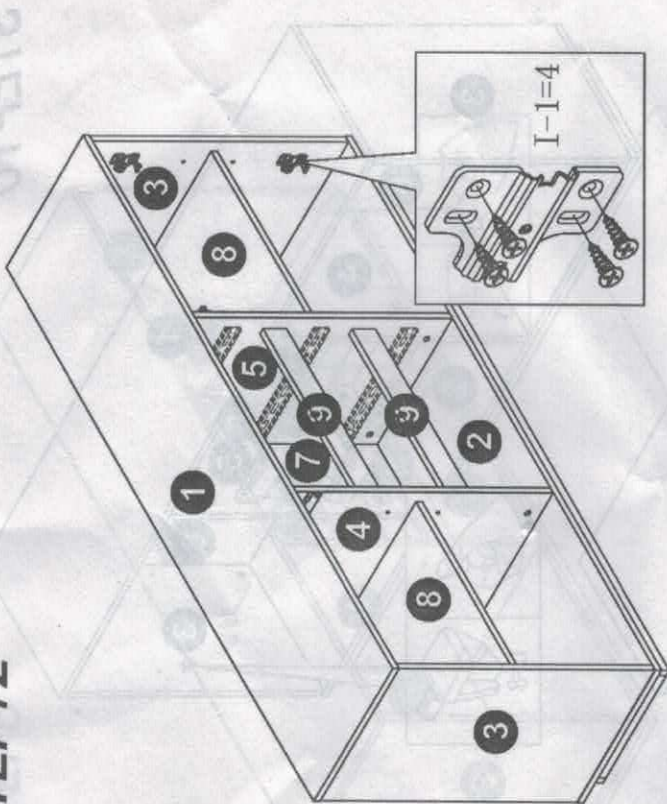

STEP13

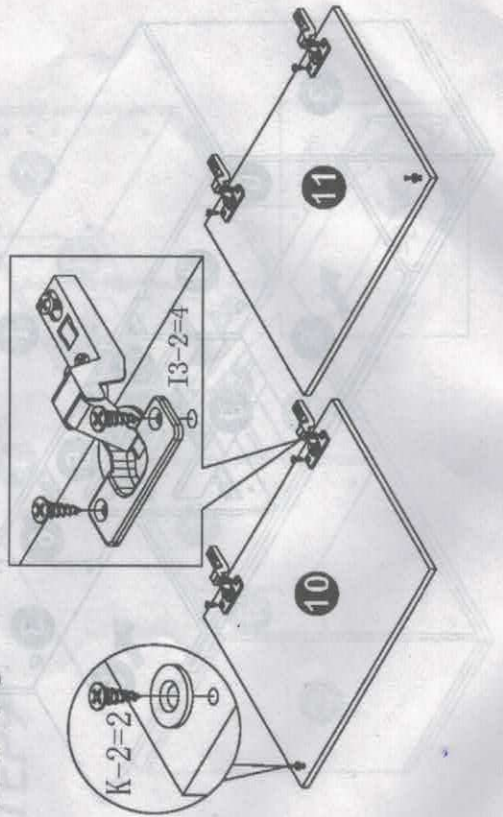

STEP14

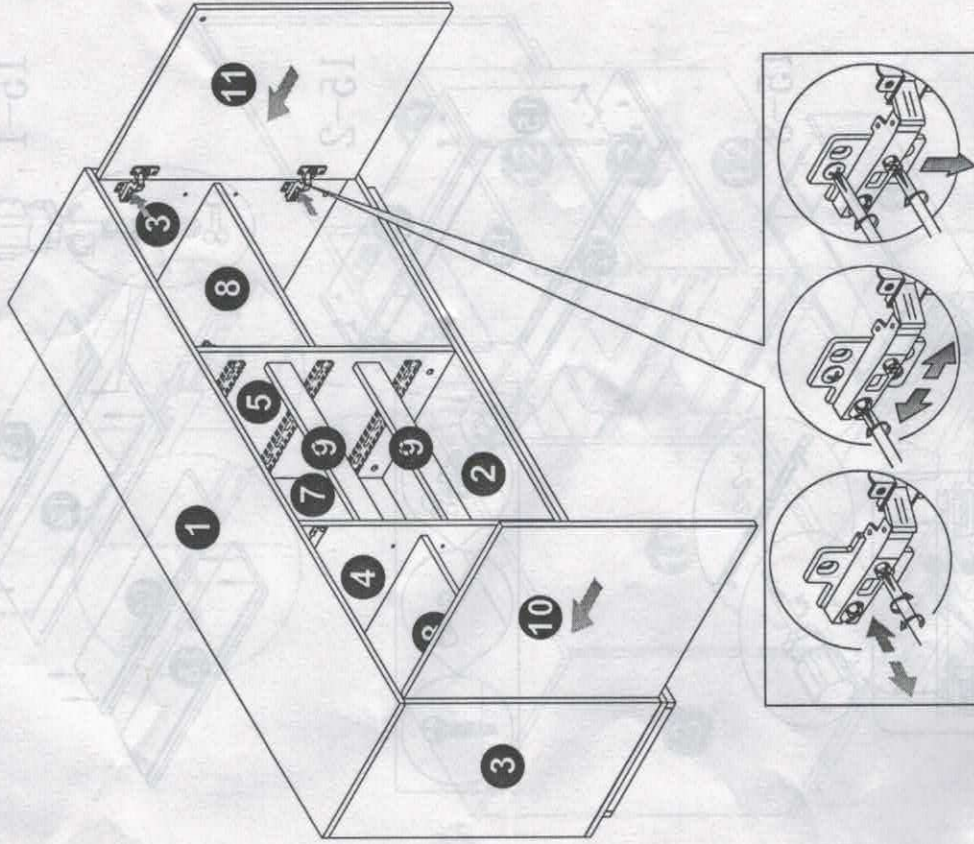

STEP15

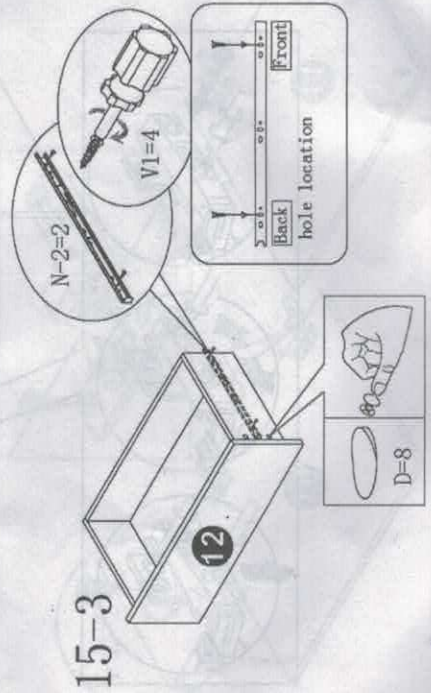
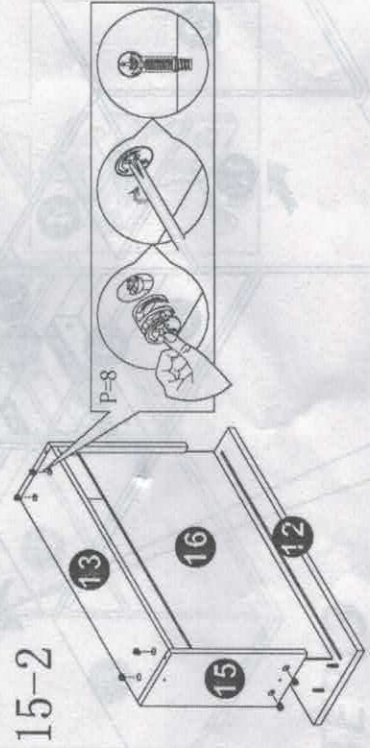
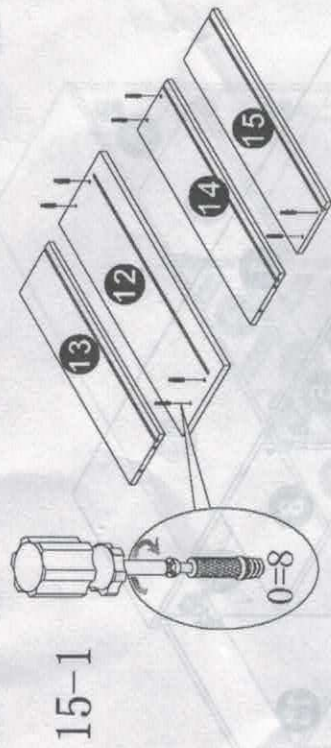

X3

STEP16

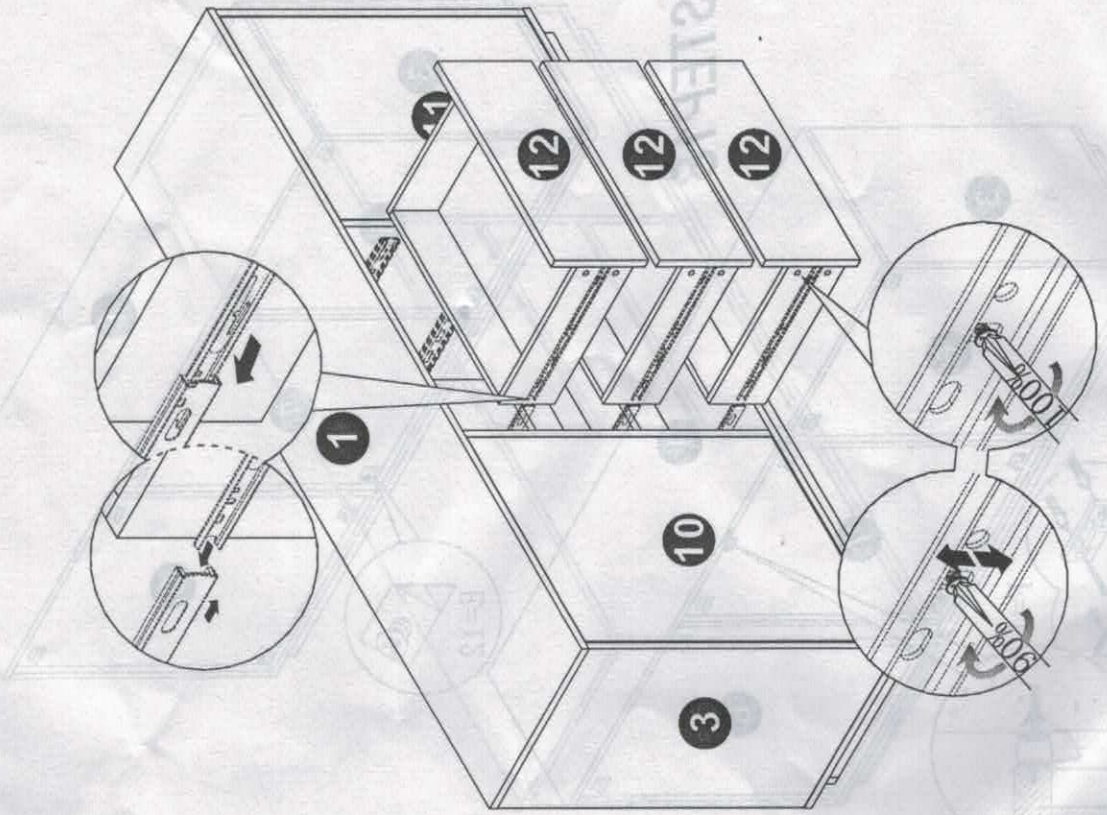

STEP17

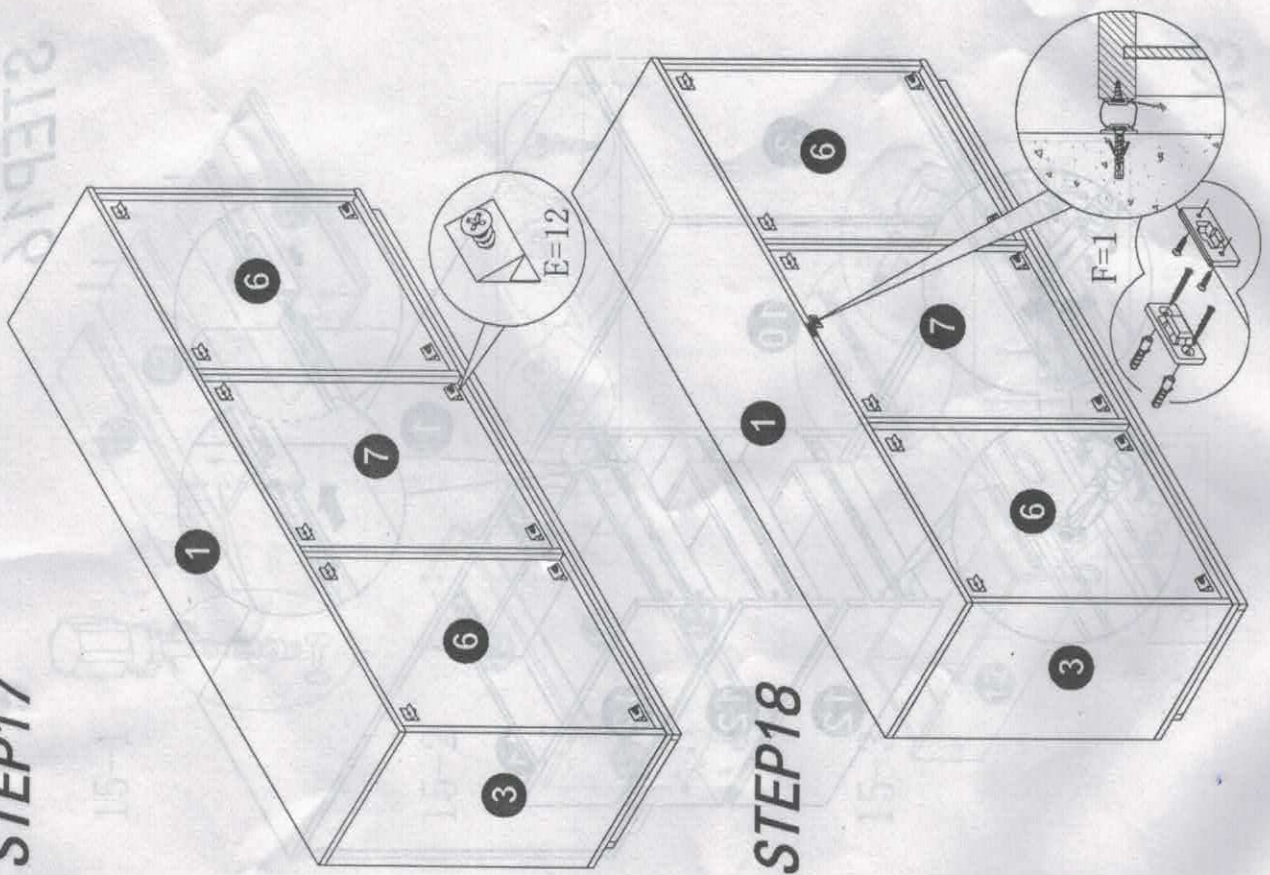

STEP18

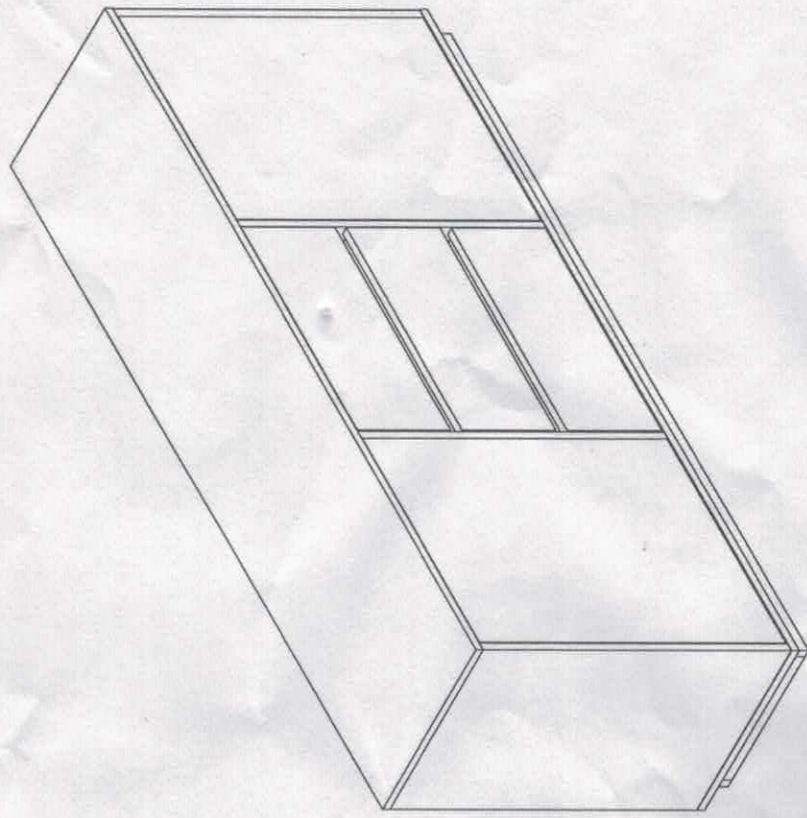

FINISH

STEP19